

# CRESCENT

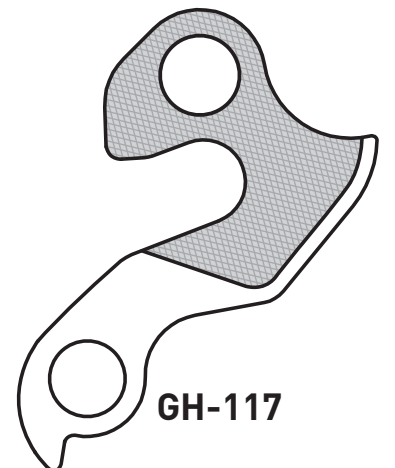

Print op ware grootte 100% (dus niet als 'passend'). Alle tekeningen zijn dan schaal 1:1

[www.marwi-eu.com/nl/gh](http://www.marwi-eu.com/nl/gh)

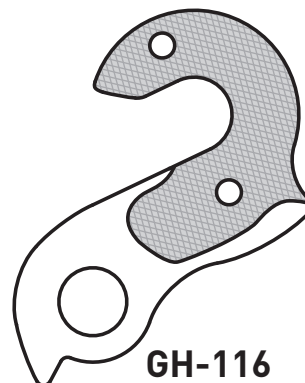
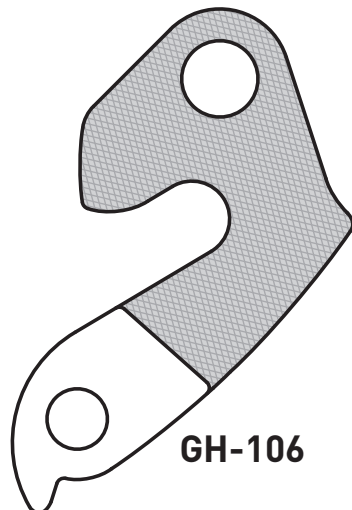
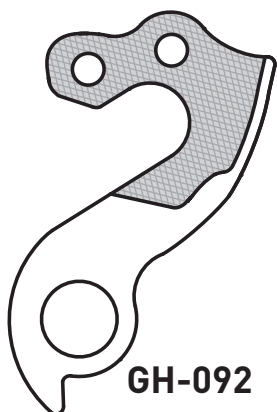
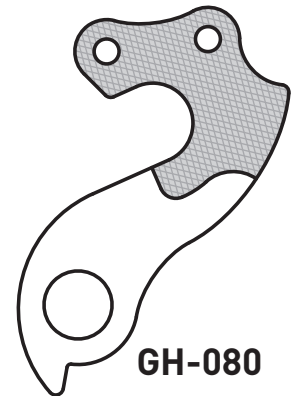
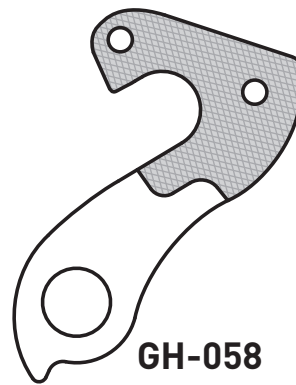
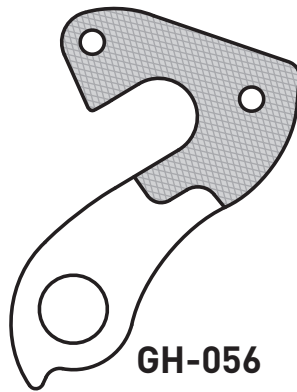
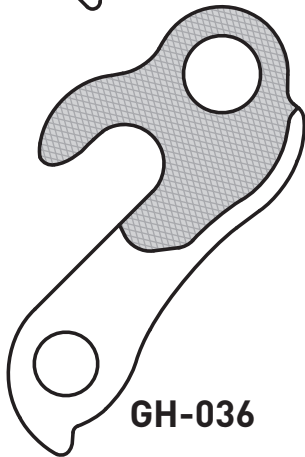
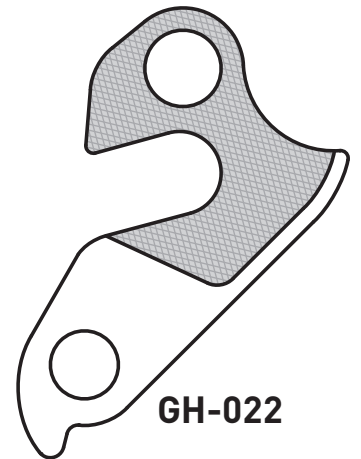
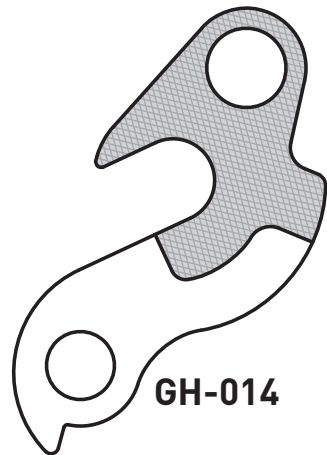
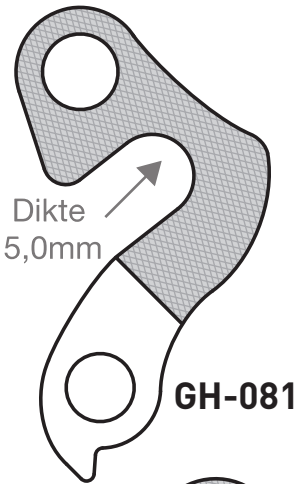
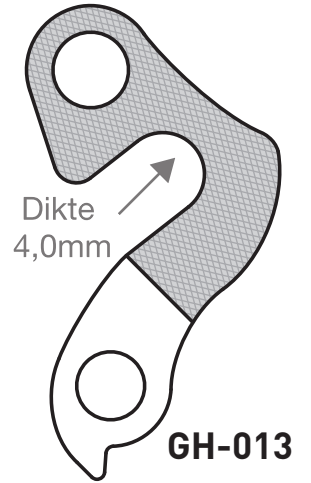
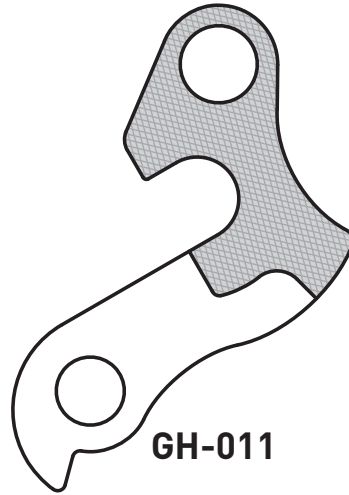
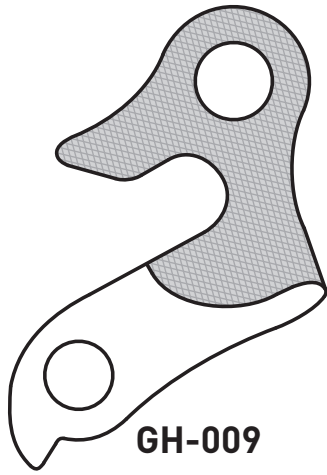
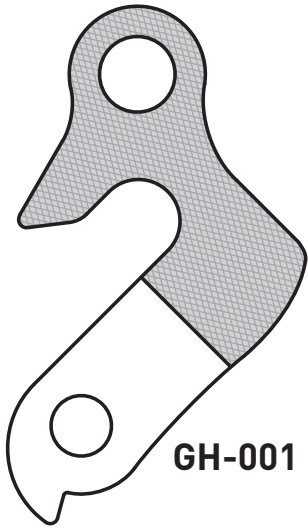

# CRESCENT

