

# CORRATEC (1)

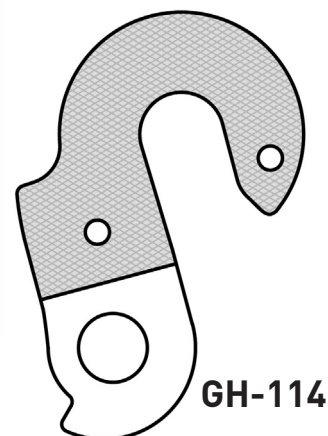

Print op ware grootte 100% (dus niet als 'passend'). Alle tekeningen zijn dan schaal 1:1

[www.marwi-eu.com/nl/gh](http://www.marwi-eu.com/nl/gh)

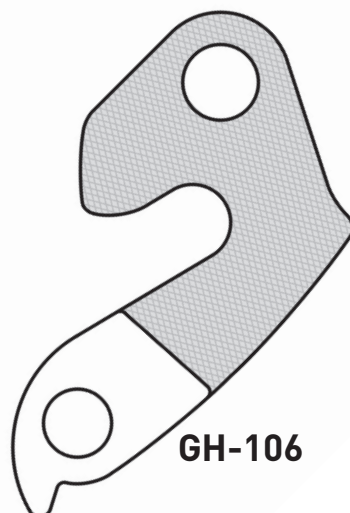
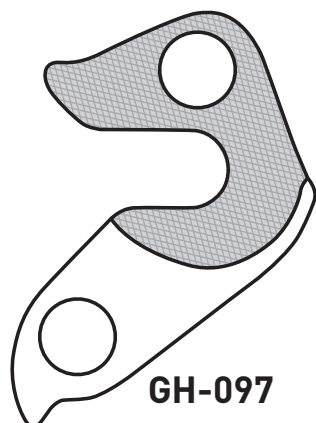
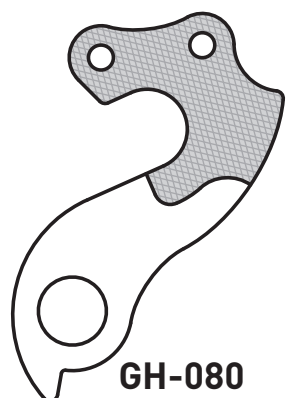
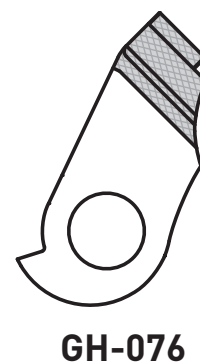
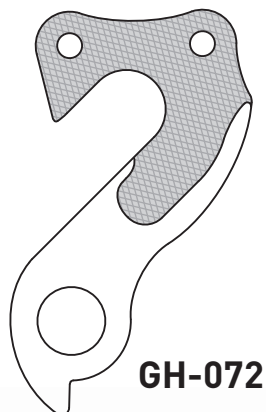
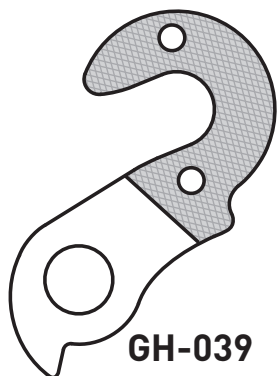
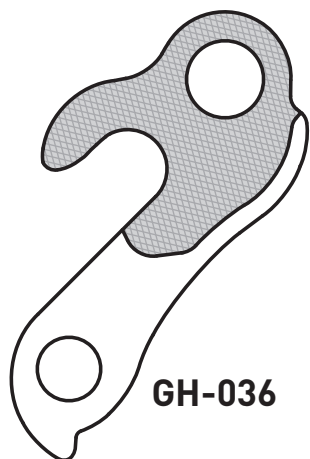
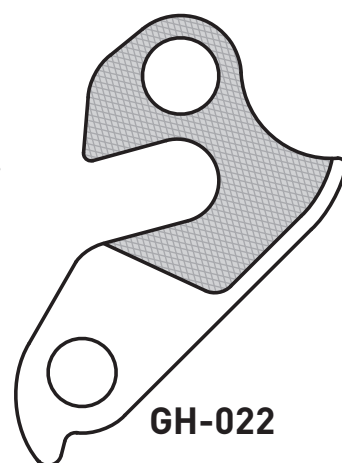
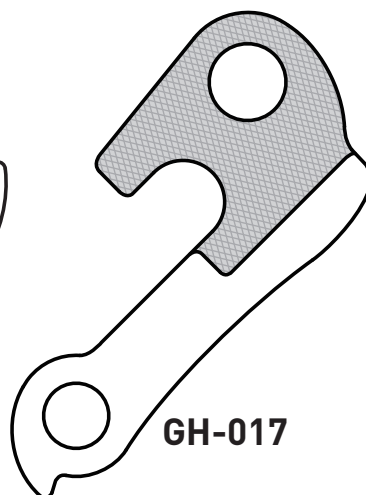
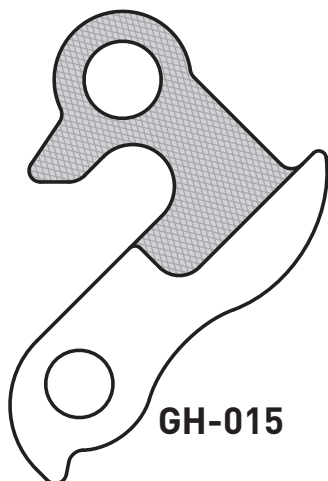
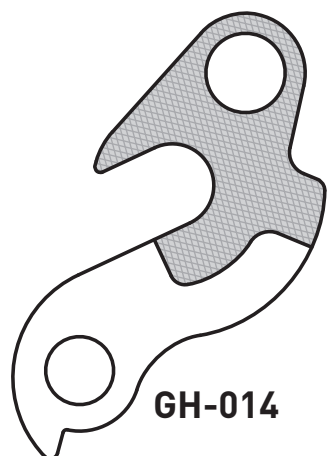
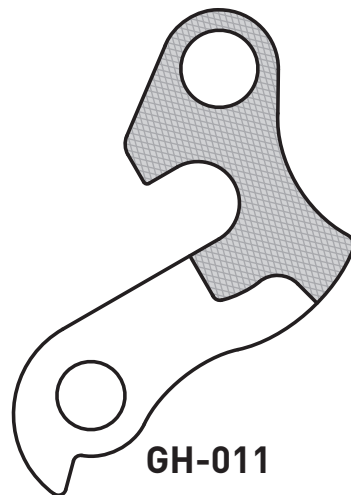
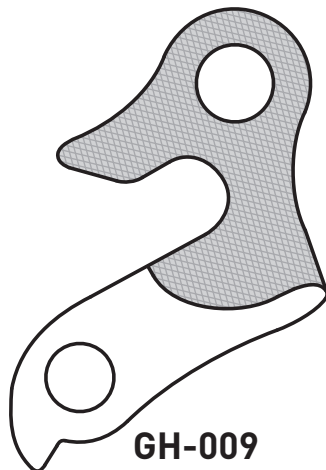
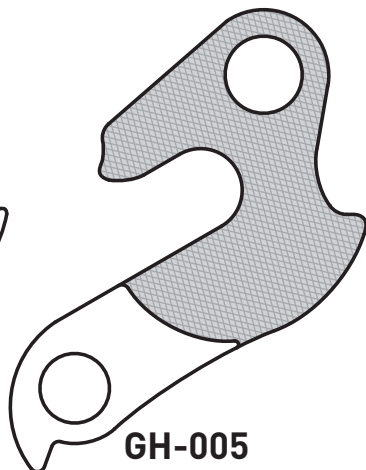
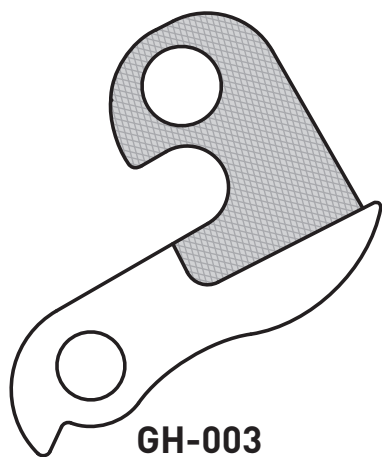

## CORRATEC (2)

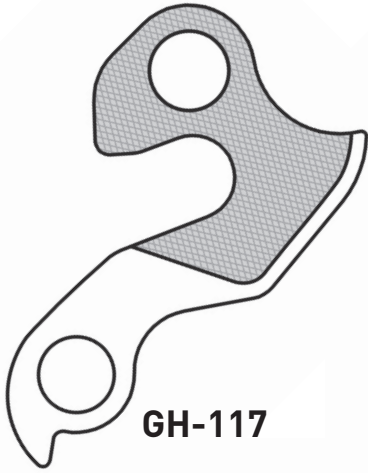

**GH-117**

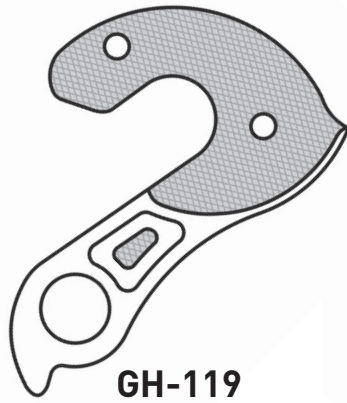

**GH-119**

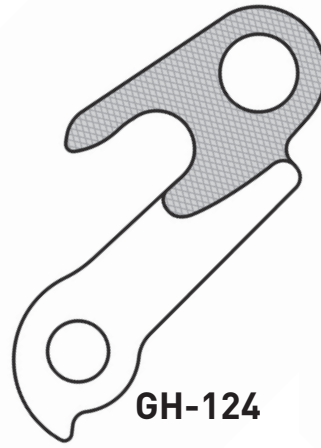

**GH-124**

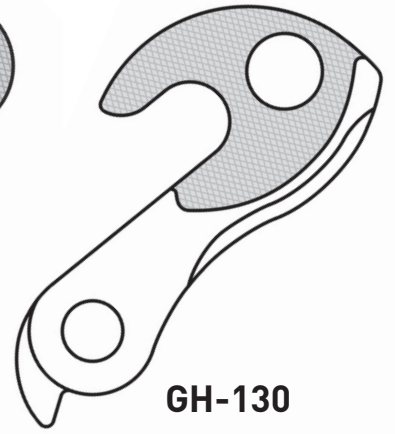

**GH-130**

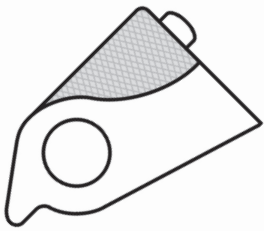

**GH-131**